

326X V.34 Series Modem Release 7.3/8.1 Software Upgrade Instructions

Overview

Introduction

This notice **explains how to upgrade** 326X V.34 Series Modem software by replacing the unit's programmable read-only memory (PROM) chips. This upgrade is for *stand-alone* and *Modulus Enclosure card* modems.

The software releases are as follows:

- Release 7.3 is for 4-PROM modems running Release 7.1 or 7.2 software
- Release 8.1 is for 2-PROM modems running release 7.01 or 7.5 through 8.0

Do not upgrade modems that are running software Releases lower than 7.0 with this kit.

Motorola recommends that:

- You read this notice completely before beginning to upgrade equipment
- If you plan to upgrade more than one unit, you complete one upgrade before proceeding to the next
- You obtain the updated *326X Series V.34, V.34SDC, and V.32bis Series Modem User Guide*, (Part No. T0009), which documents software enhancements up to the present.

In this Notice

Topic	See Page
In This Release	4
PROM Installation Overview	5
Preparing to Upgrade a Stand-Alone Modem	6
Upgrading a Stand-Alone Modem.....	8
Reassembling a Stand-Alone Modem	11
Testing PROM Installation in a Stand-Alone Modem	12
Preparing to Upgrade an Enclosure Card Modem.....	13
Upgrading a Modulus Enclosure Card Modem	14
Reassembling and Testing a Modulus Enclosure Card Modem	17
Reconfiguring Modem Options (Stand-Alone and Enclosure-Card)	18



Obtaining Documentation

To order 326X modem documentation, including the *326X Series V.34 Modem User's Manual* and *Reference Guide*, call the Motorola ISG publications order department at (508) 261-5933, or download viewer files from the Motorola World-Wide Web site (<http://www.mot.com/MIMS/ISG/>).



Warning!

Only **qualified service personnel** should perform the upgrade procedure. A qualified service person is one who is familiar with the 326X product line operation, trained in the technology of electrically powered information processing and business equipment and adequately aware of the hazards associated with this equipment. Use of this procedure by unqualified personnel could result in **personal injury** or **equipment damage**, which could jeopardize your warranty and maintenance agreement.

Users who are not qualified to perform an upgrade themselves should contact Motorola or an authorized distributor regarding available upgrade services.



Caution!

Some components in the modem are sensitive to **static electric discharges**; such discharges can **damage** these components. Use proper handling and grounding precautions (described in this document) when handling components.

Compatibility Warranty

Warranties for Motorola 326X V.34 modems upgraded with this PROM Upgrade Kit are as follows.

Warranty Information

Motorola 326X V.34 Modem	Warranty Status
Still under factory warranty	Modem is covered under the warranty of the original purchased modem.
Out of factory warranty	PROM Upgrade Kit is warranted for 90 days from date of shipment. Support is limited to Factory Return and Repair.

Upgrade Kit Contents

Figure 1 shows the contents of the Upgrade Kit.

Some Modulus Enclosure card units have two modems on one card; to upgrade these, use two upgrade kits.

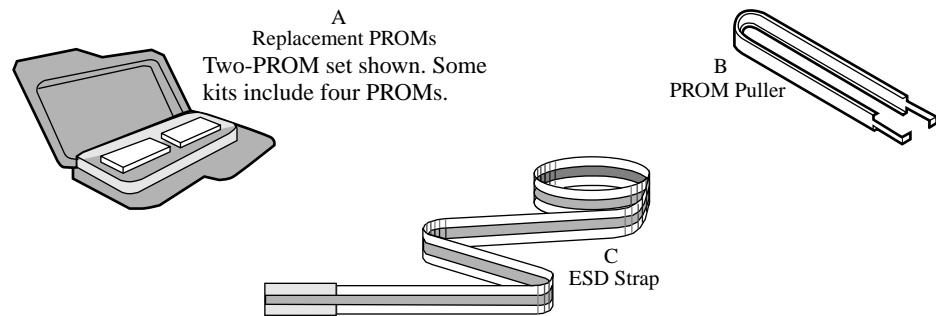

Figure 1. Upgrade Kit Contents

In This Release

In This Release

Software Functions Release 7.3/8.1 enables 326X modems to operate with V.90 modems in dial-up connections. With this software, 326X modems can communication with V.90 modems and negotiate V.34 rates. The release does not provide 56K rates for 326X modems, nor 326X rates higher than the V.34 33.6 KBPS standard.

The upgrade is not required for modems used only in leased-line applications.

PROM Installation Overview

Installation Overview

Upgrading a 326Xmodem is accomplished by replacing PROMs on a circuit card. PROM access and positioning varies between the **stand-alone** and enclosure **card** modem. This document provides separate instructions for each type.

Both types of modems require:

- Inspection of new PROMS (described in this section)
- Reconfiguration after PROM replacement (described in the final section)

Inspecting New PROMs (All Modems)

Before beginning any other procedures, inspect the new PROMs as follows. This applies to stand-alone *and* enclosure card modems.

Inspecting New PROMs

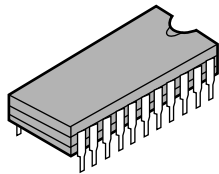

Step	Action	Result
1	Verify that the PROMs are marked: <ul style="list-style-type: none"> • G01 and G02, in a 2-PROM kit • G01, G02, G03, and G04, in a 4-PROM kit 	
2	Remove the new PROMs from the package. Inspect them for damage. The pins must be straight --not bent.	If any PROMs are damaged , arrange for replacement as follows: <ul style="list-style-type: none"> • In the U. S. A., call Motorola Customer Support at (800) 544-0062 • Outside the U. S. A., call your Motorola distributor
3	Replace the PROMs in the package.	

Preparing to Upgrade a Stand-Alone Modem

Recording Modem Configuration Settings

The first step in preparing to upgrade is to write down or electronically save any non-default settings and telephone numbers, so you can reconfigure them after the upgrade. This data is lost during PROM installation.

The way to record this data varies with the modem configuration, as follows.

Recording Modem Configuration Settings

For:	Perform These Steps:
All modems:	Write down configuration settings; stored telephone numbers; and any changes made to the four default option sets. (Use AT *ST to display current options.) Use the Configuration Worksheets in the <i>326X V.34 Series Modem User's Manual</i> .
Modems managed by a Motorola 9000-UX or 9000-PC:	Write down the modem's NC Address and NC port rate. Use the Upload command to copy the modem's active configuration to the NMS.
Modems managed by a Motorola 9110 NMS:	Copy the modem's active configuration to a template, using the 9110's Config Copy command.
Modems managed by a Motorola 9300 NMS or 9800 NMS:	Write down the modem's NC Address and NC port rate. Use the Upload command to copy the modem's active configuration to the NMS.

Disconnecting Stand-Alone Modem Hardware

Refer to the following table for the remaining stand-alone-modem upgrade preparation steps.

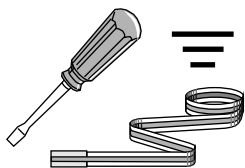

Disconnecting Stand-Alone Modem Hardware

Step	Action	Result
1	Obtain a flathead screwdriver.	
2	Attach the ESD strap to your wrist and to a grounded item.	Any electrostatic energy is discharged from you.
3	Turn the modem power OFF. Disconnect the power cord from the modem.	Power is removed from the unit.
4	Disconnect all cables from the modem.	
5	Open the modem front panel door. Hold it at a 90° angle to the front panel. Push down to disengage the snap hinges from the base.	The door can be set aside.

Preparing to Upgrade a Stand-Alone Modem

Disconnecting Stand-Alone Modem Hardware (continued)

Step	Action	Result
6	Insert a screwdriver into an enclosure slot at a 45° angle as shown in Figure 2. Gently press upward and twist to release the clip from the cover. Repeat for all clips. Pry the cover off	The cover can be removed and set aside. Preparation is complete.
7	Go on to Upgrading a Stand-Alone Modem.	



Caution!

Use care when inserting the screwdriver into the modem enclosure slots. If inserted too deeply, the tool may damage the enclosure base.

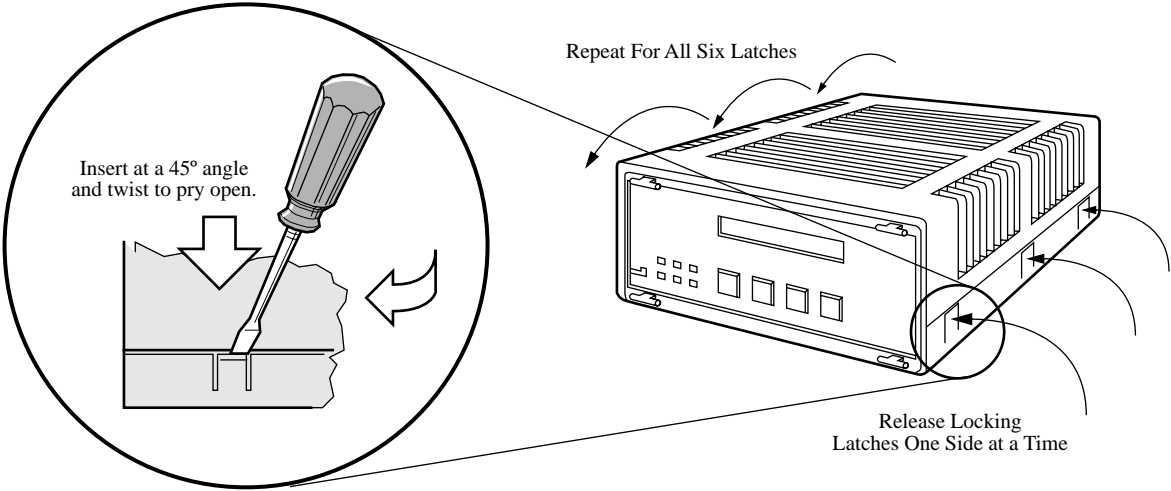

Figure 2. Opening a Stand-Alone Modem Enclosure

Upgrading a Stand-Alone Modem

Introduction

To upgrade a standalone modem, you replace the old PROMs with new ones. To remove the PROMs, use the following procedure.

PROM Removal for a Stand-Alone Modem

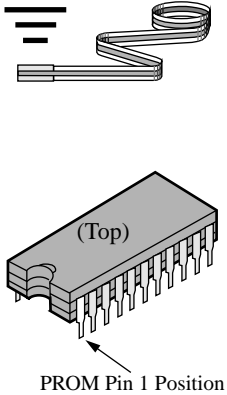

Step	Action	Result
1	Turn the modem to face you.	
2	Verify that the ESD strap is attached to your wrist and a grounded point.	
3	Hold the PROM puller at a 90° angle to PROM G01. Gently loosen the PROM pins by pulling up as shown in Figure 3 and rocking the PROM from end to end. You may press down on the unit to brace it.	The PROM is removed. Note the notch on the top of the PROM; it indicates the position of Pin 1.
4	Remove PROMs G01 and G02 from the modem. In a four-PROM kit, also remove G03 and G04.	PROM removal is complete. Set aside old PROMS until the upgrade is complete; then you may dispose of them.
5	Go on to PROM Installation for a Stand-Alone Modem.	

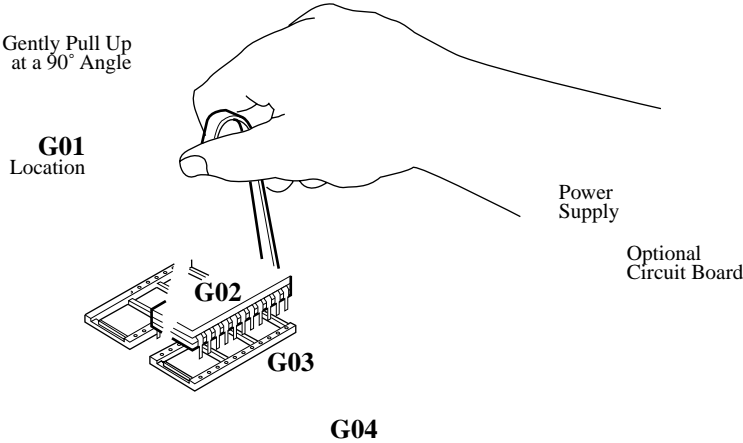

Figure 3. Removing PROMs From a Modem—Pull Straight Up

Upgrading a Stand-Alone Modem

Installing New PROMs



After removing the old PROMs from the modem, you install the new PROMS.

Caution!

Ensure that the PROM is properly aligned with the card, *and* that all PROM pins are properly aligned with the socket receptacles before pressing on the PROM. If a PROM is not correctly aligned before inserting, it will be damaged. Press **gently**, with equal pressure on both sides, until pins are seated in the sockets.

To install the new PROMs, use the following procedure.

Installing PROMS in a Stand-Alone Modem

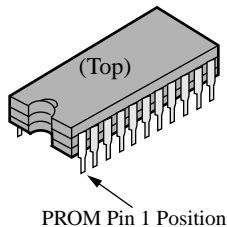
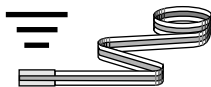

Step	Action	Result
1	Attach the ESD strap to your wrist and a grounded point.	
2	Remove PROM G01 from its package. Note the notch on the top; it indicates Pin 1's position.	
3	Note PROM orientation (with modem front panel toward you): the notches face the back of the modem, away from you.	The PROM is oriented as shown in Figure 4.
4	Lay the PROM on its socket; be sure that Pin 1 is oriented correctly and the pins are properly aligned.	The pins are aligned with the receptacles.
5	Press the PROM into its socket.	The PROM is installed.
6	With a two-PROM unit, install G02. With a four-PROM kit, install G02, G03 and G04.	
7	Ensure that the PROMs are located, aligned and oriented correctly and that all the pins are fully seated in the receptacles.	PROMs are installed and oriented correctly. If a PROM is incorrectly installed, contact Motorola Customer Support, as described in PROM Installation Overview.
8	Attach the large upgrade label to the front panel (Figure 4).	The modem can be identified as upgraded.
9	Go on to Reassembling a Stand-Alone modem.	

Upgrading a Stand-Alone Modem

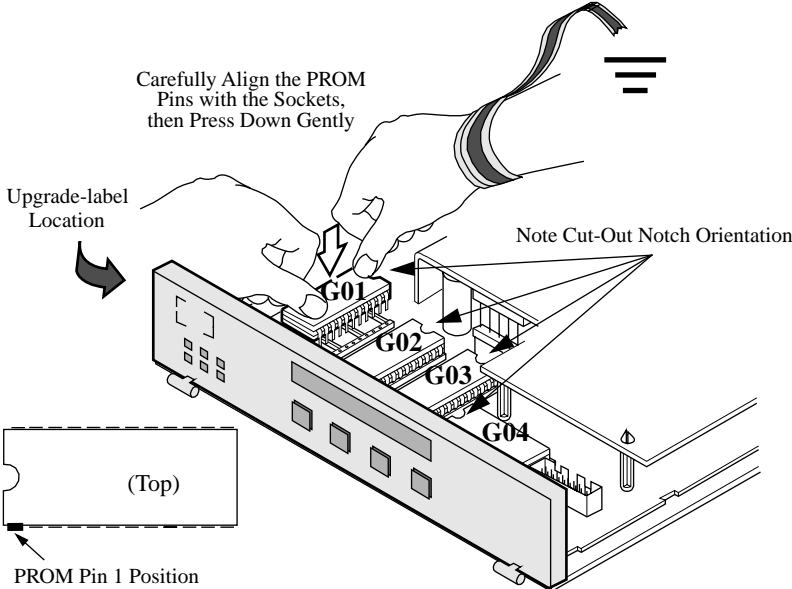

Four-PROM unit shown. Some units have only two PROMS, G01 & G02.

Figure 4. Placing New PROMs in Modem



Reassembling a Stand-Alone Modem

Reassembling a Stand-Alone Modem

Introduction

After installing the PROMs, you reassemble the modem.

**Stand-Alone
Modem Assembly**

The modem cover must be replaced and cables must be reconnected before the unit is ready for test. To reassemble the modem, perform the following steps.

Assembling a Stand-Alone Modem

Step	Action	Result
1	Align the modem-cover notches with the modem-base guides, and position the modem-cover groove with the backplane edge. Push down to lock the cover into place.	The cover snaps into place.
2	Position the front door against the front panel at a 90° angle.	
3	Press on the door hinges to snap them into place.	The door snaps into place.
4	Connect the power cord.	The unit is assembled.
5	Go on to Testing PROM Installation in a Stand-Alone Modem.	

Testing PROM Installation in a Stand-Alone Modem

Introduction

After replacing the PROMs, you test for proper operation, as follows.

PROM Replacement Test Procedure

Step	Action	Result
1	Turn the modem power ON.	After 15 seconds, the LCD displays 326X Fast Init . If it doesn't, see the checklist below. If it still does not display, contact Motorola Customer Support, as described in PROM Installation Overview. Provide the error-code, if one displays.
2	If the LCD displays correctly, turn the modem power OFF.	
3	Reconnect cables to the modem.	
4	Turn the modem power ON.	The unit is ready for configuration.
5	Go on to Reconfiguring Modem Options.	

No-Initialization Checklist (From Step 1 Above)

Power	Ensure that the power cord is firmly plugged in to the modem and the power source. If it is not, correct it and repeat the test procedure.
PROM Order, Orientation, and Seating	Using the procedure in PROM Installation for a Stand-Alone Modem, ensure that all PROMs are: <ul style="list-style-type: none">• Positioned in the correct order on the card• Oriented correctly• Seated flat on the receptacles, with all pins straight If a PROM is wrong, contact Motorola Customer Support, as described in PROM Installation Overview.

Preparing to Upgrade an Enclosure Card Modem

Recording Modem Configuration Settings

The first step in preparing for the upgrade procedure is to write down and/or electronically save any non-default settings and telephone numbers, so you can reconfigure them after the upgrade. This data is lost during PROM installation.

Record this data depending on the modem configuration as follows.

Recording Modem Configuration Settings

For:	Perform These Steps:
All modems:	Write down configuration settings; stored telephone numbers; and any changes made to the four default option sets. (Use AT *ST to display current options.) Use the Configuration Worksheets in the <i>326X V.34 Series Modem User's Manual</i> .
Modems managed by a Motorola 9000-UX or PC	Write down the modem's NC Address and NC port rate. Use the Upload command to copy the modem's active configuration to the NMS.
Modems managed by a Motorola 9110 NMS:	Copy the active configuration to a template, using the 9110's Config Copy command.
Modems managed by a Motorola 9300 NMS or 9800 NMS:	Write down the modem's NC Address and NC port rate. Use the Upload command to copy the modem's active configuration to the NMS.

Preparing to Upgrade an Enclosure Card Modem

Perform the following steps to prepare for the PROM upgrade.

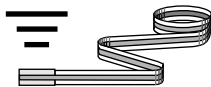

Preparing to Upgrade a Modulus Enclosure Modem

Step	Action	Result
1	Attach the ESD strap to your wrist and to a grounded item.	Any electrostatic energy is discharged from you.
2	Remove the card from the enclosure.	Preparation is complete.
3	Go on to PROM Replacement for a Modulus Enclosure Modem.	

Upgrading a Modulus Enclosure Card Modem

Introduction

To upgrade a Modulus Enclosure modem, you replace the old PROMs with new ones. To remove the PROMs, use the following procedure.

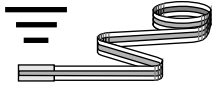

PROM Removal for a Modulus Enclosure Modem

Step	Action	Result
1	Verify that the ESD strap is attached to your wrist and a grounded point.	
2	Hold the PROM puller at a 90° angle to PROM G01. Gently loosen the PROM pins by pulling up as shown in Figure 5 and rocking the PROM from end to end. You may press down on the unit to brace it.	
3	Remove PROMs G01 and G02 from the modem. In a four-PROM kit, remove G03 and G04.	
4	On cards that have two modems, repeat Step 3 for the second set of PROMs.	PROM removal is complete. Set aside old PROMS until the upgrade is complete; then you may dispose of them.
5	Go on to PROM Installation for Modulus Enclosure Modems.	

Upgrading a Modulus Enclosure Card Modem

Installing New PROMs

After removing the old PROMs from the modem, you install the new PROMS.



Caution!

Ensure that the PROM is properly aligned with the card, *and* that all PROM pins are properly aligned with the socket receptacles before pressing on the PROM. If a PROM is not correctly aligned before inserting, it will be damaged. Press **gently**, with equal pressure on both sides, until pins are seated in the sockets.

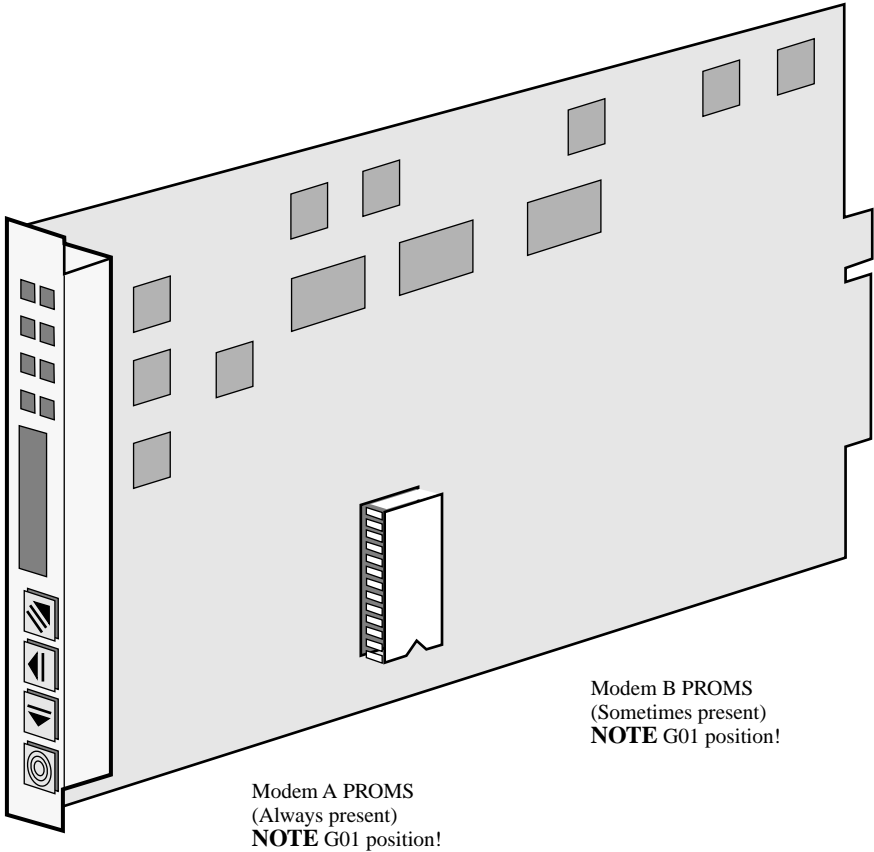
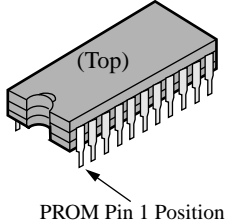
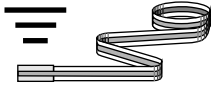

Figure 5. Dual-Modem Card, Four PROMs Per Modem Shown

Upgrading a Modulus Enclosure Card Modem

To install the new PROMs, use the following procedure.

Installing PROMS in a Modulus Enclosure Modem



Step	Action	Result
1	Attach the ESD strap to your wrist and a grounded point.	
2	Remove PROM G01 from its package. Note the notch on the top; it indicates Pin 1's position.	In case of damage, call Motorola Customer Support, as described in PROM Installation Overview.
3	Lay the PROM on its socket; be sure that Pin 1 is oriented correctly and the pins are properly aligned.	The PROM is oriented as shown in Figure 5, and the pins are aligned with the receptacles.
4	Press the PROM into its socket.	The PROM is installed.
5	With a two-PROM unit, install G02. With a four-PROM kit, install G02, G03 and G04.	
6	Ensure that the PROMs are located, aligned and oriented correctly and that all the pins are fully seated in the receptacles.	PROMs are installed and oriented correctly. If a PROM is incorrectly installed, contact Motorola Customer Support.
7	Attach the small upgrade label on the card edge (Figure 5).	The modem can be identified as upgraded.
8	For cards that have two modems (A and B), repeat Steps 2-6 on the second set of PROMs (Modem B).	PROM installation is complete for two modems on card.
9	Go on to Reassembling a Modulus Enclosure Modem.	

Reassembling and Testing a Modulus Enclosure Card Modem

Introduction

After replacing PROMs, you replace the modem card in the Modulus enclosure, and then test for proper PROM installation.

Reassembling and Testing a Modem

To reassemble and test a modem, follow the procedure below.

Reassembling and Testing a Modulus Enclosure Card Modem

Step	Action	Result
1	Place the card back into the Modulus enclosure.	After 15 seconds, the LCD displays 326X Fast Init . If it doesn't, see the checklist below. For dual-modem cards: the first display refers to the currently-selected modem.
2	For dual-modem cards: change the modem-selector switch.	After 15 seconds, the LCD displays 326X Fast Init . If it doesn't, see the checklist below. If there is a problem, contact Motorola Customer Support. Provide the error-code, if one displays. Installation test is complete.
3	Go on to Reconfiguring Modem Options.	

No-Initialization Checklist (From Step 1 and 2 Above)

Power	Ensure that the power cord is firmly plugged in to the modem enclosure and the power source. If it is not, correct it and repeat the test procedure.
PROM Order, Orientation, and Seating	Using the procedure in PROM Installation for a Modulus Enclosure Modem, ensure that PROMs are: <ul style="list-style-type: none"> • Positioned in the correct order on the card • Oriented correctly • Seated flat on the receptacles, with all pins straight If a PROM is wrong, contact Motorola Customer Support.

Reconfiguring Modem Options (Stand-Alone and Enclosure-Card)

Overview

You reconfigure parameter options, telephone numbers and option sets after testing the PROMs. This applies to stand-alone *and* Modulus enclosure card modems.

Reconfiguring the Modem

Reconfiguring the modem means programming it with the options it had before the PROM upgrade. Configuration varies with the network-management environment.

Reconfiguring a Modem That is Not Managed by a Network Management System

Step	Action	Result
1	Enter the non-default option-set options recorded before the upgrade.	
2	Enter the active configuration recorded before the upgrade.	Configuration is loaded to modem(s).
3	Enter the telephone number(s) recorded before the upgrade.	Modem is ready for operation.

Reconfiguring a Modem That is Managed by a Network Management System

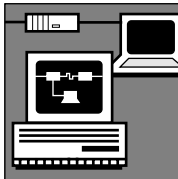

Step	Action	Result
1	Enter the telephone number(s) recorded before the upgrade.	
2	Enter the non-default option-set options recorded before the upgrade.	
3	Ensure that the network manager re-attaches to the modem.	
4	Restore (download) the saved modem configuration from the network manager to the modem(s), if applicable.	Configuration is loaded to modem(s).
5	Invoke new features as needed.	Modem is ready for operation.